

THIS DRAWING IS INDICATIVE ONLY AND BY NO MEANS COMPREHENSIVE

FRONT

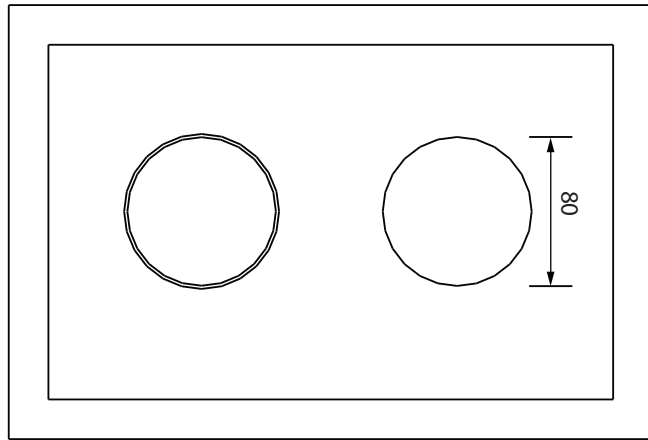

TOP

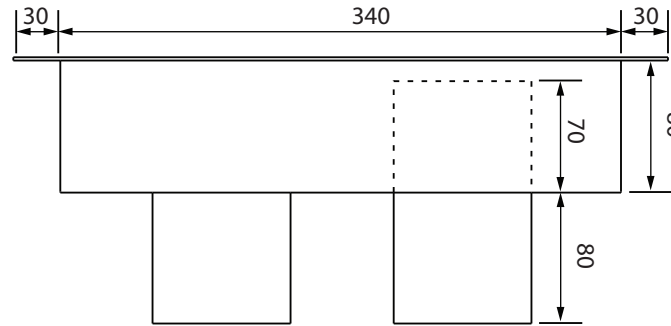

RIGHT

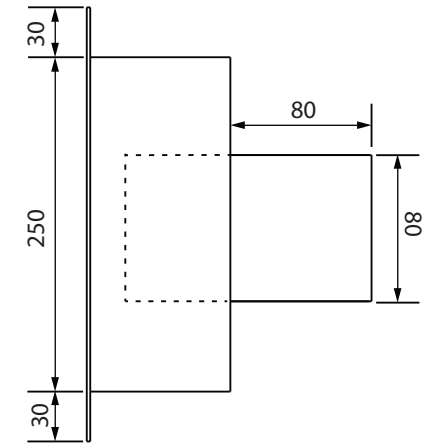

ISOMETRIC

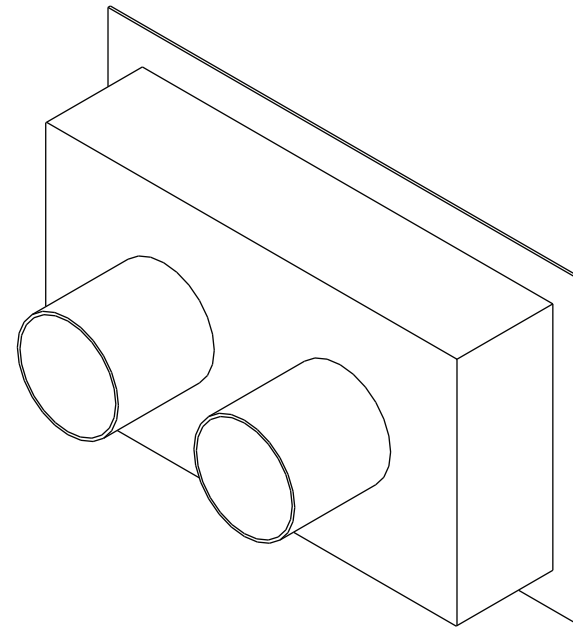
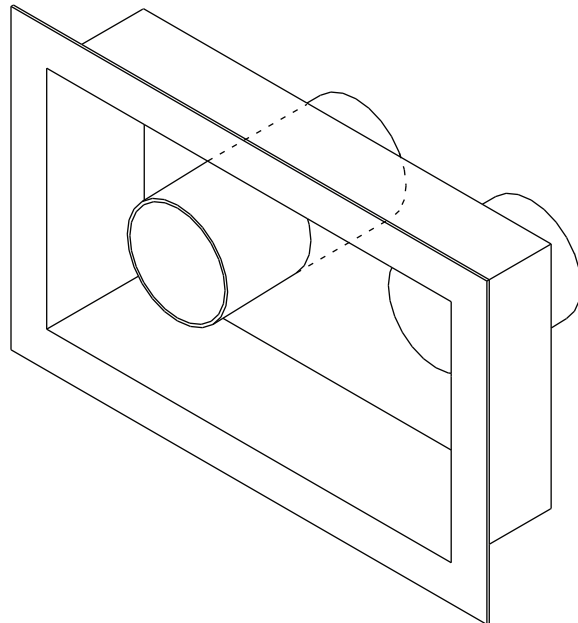

PEALUSUMP80

- 340.250.80mm

SUMP

80mm ROUND OUTLET

& OVERFLOW